









THREE-WAY THERMOSTATIC BATHTUB MIXER WITH SPOUT, 200MM HEAD SHOWER AND HAND SHOWER

formma.

GR.01.3.04.XX



AVAILABLE FINISHES

-  **CR** | Chrome
-  **IE** | Brushed stainless steel
-  **BL** | Black
-  **WH** | White
-  **BB** | Brushed Black *PVD
-  **BR** | Brushed Bronze *PVD
-  **BC** | Brushed Copper *PVD
-  **BG** | Brushed gun metal *PVD
-  **BW** | Brushed white gold *PVD

TECHNICAL DRAWING (MEASUREMENT IN MM)

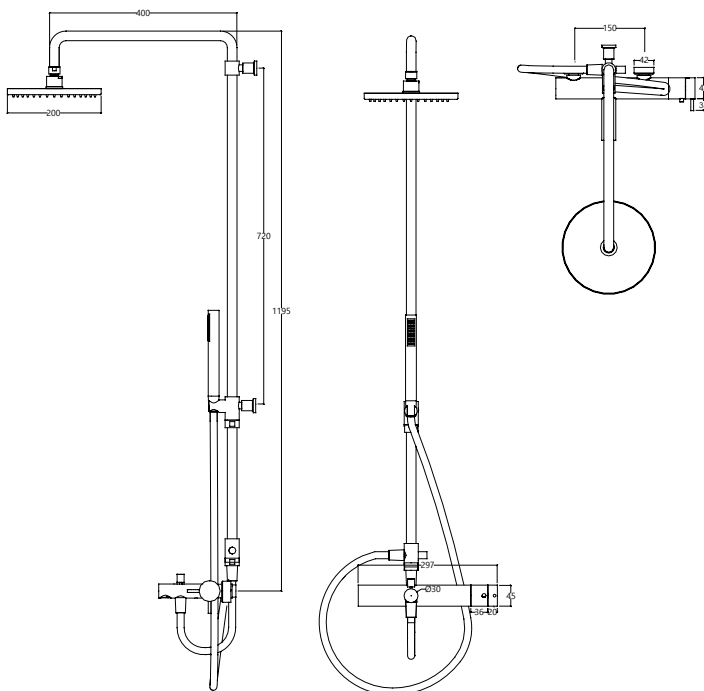

INSTALLATION RECOMENDATIONS

Before installing a tap, it is good to rinse the supply pipes to remove all residues. We also recommend installing the taps with a filter. The installation of the tap must be done with the surface clean and dry. To perform the water pressure test, the taps must be open.

CLEANING AND MAINTENANCE

Cleaning must be done with liquid soap and water. Do not use liquid detergents containing abrasive or acidic substances, abrasive sponges or disinfectants. Incorrect cleaning may permanently ruin the surface of taps. On color finishings, do not use products containing alcohol, acetone and other solvents.

WARRANTY

Formma guarantees all its products in case of manufacturing defects, as follows:

- 5-year warranty:
 - Fusion or porosity defects;
 - Cartridge defects (the wear of this component depends on water quality);
 - Chrome plating defects (defects caused by maintenance errors are excluded, please refer to cleaning instructions).
- 1-year warranty:
 - O-rings or fittings defects.
 - Defects on remaining finishes.

In order to use this warranty, please keep the invoice and attach it to this document.

Warranty grants the right of free replacement of parts that cause an irregular operation due to manufacturing defects, in every cases in which malfunction is not caused by incorrect use, maintenance errors, irregular installation, assembly made by unqualified people or reasons of force majeure.

Defective products must be sent to formma, with shipping expenses borne by the sender – this warranty document and a copy of the purchase invoice must be attached to the package – where the products will be promptly replaced and send back with shipping expenses borne by formma.

Non-compliance of this conditions will render the warranty null and void. This warranty excludes any liabilities on the consequences arising from use or installation defects of formma products.

COMPONENT DRAWING

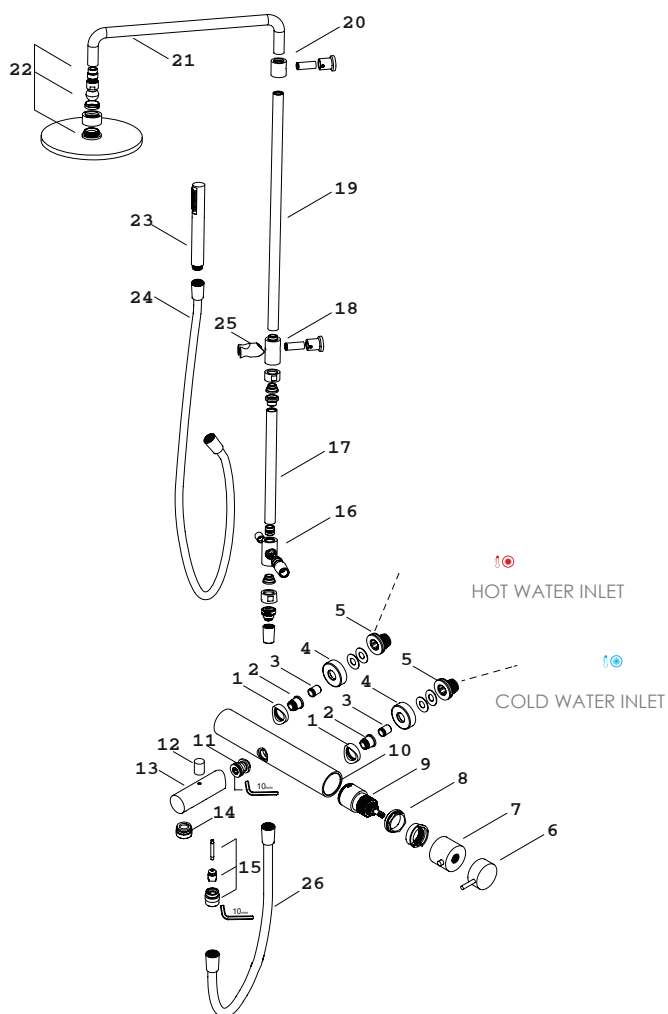

TECHNICAL DATA

n°	DESCRIPTION
01	COLLAR FOR SEAT
02	SEAT
03	CHECK VALVE
04	PLATE
05	ECCENTRIC
06	HANDLE
07	THERMOSTATIC HANDLE
08	LOCKNUT
09	THERMOSTATIC CARTRIDGES
10	TAP BODY
11	CONNECTION COUPLING
12	HANDLE DIVERTER
13	SPOUT
14	AERATOR
15	DIVERTER